

## Cable Mounts



The multi-directional cable mounting range is manufactured using stainless steel rope and aluminium bars, & is designed to offer a maintenance free solution for use in extremely hostile environments where high levels of vibration and shock control are required.

Suitable for various military standards including: MIL-STD-167 (vibration), MIL-STD-810 (environmental conditions) & MIL-S-901 (shock).

### Cable Mounts (Type 1)

### Fitment Options

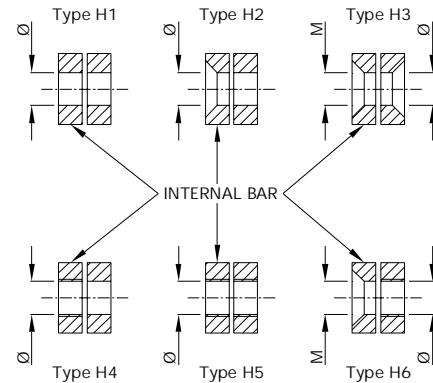
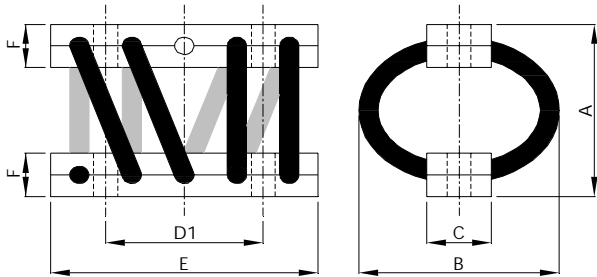

### Dimensional Data

Part No.	A (mm)	B (mm)	C (mm)	D1 (mm)	E (mm)	F (mm)	Fitment Detail	
							Ø (mm)	M
CABLE-MTG2636	50.0	60.0	16.0	46.4	90.0	13.0	7.0	M6
CABLE-MTG2637	60.0	70.0	16.0	46.4	90.0	13.0	7.0	M6
CABLE-MTG2638	70.0	80.0	16.0	46.4	90.0	13.0	7.0	M6
CABLE-MTG2639	80.0	90.0	16.0	46.4	90.0	13.0	7.0	M6
CABLE-MTG2640	90.0	100.0	16.0	46.4	90.0	13.0	7.0	M6
CABLE-MTG2641	85.0	110.0	16.0	46.4	90.0	13.0	7.0	M6
CABLE-MTG2642	50.0	60.0	16.0	46.4	90.0	13.0	7.0	M6
CABLE-MTG2643	55.0	65.0	16.0	46.4	90.0	13.0	7.0	M6
CABLE-MTG2644	60.0	70.0	16.0	46.4	90.0	13.0	7.0	M6
CABLE-MTG2645	65.0	80.0	16.0	46.4	90.0	13.0	7.0	M6
CABLE-MTG2646	70.0	100.0	16.0	46.4	90.0	13.0	7.0	M6
CABLE-MTG2647	80.0	110.0	16.0	46.4	90.0	13.0	7.0	M6
CABLE-MTG2648	75.0	90.0	25.0	66.8	128.0	16.0	7.0	M6
CABLE-MTG2649	90.0	110.0	25.0	66.8	128.0	16.0	7.0	M6
CABLE-MTG2650	100.0	115.0	25.0	66.8	128.0	16.0	7.0	M6
CABLE-MTG2651	110.0	135.0	25.0	66.8	128.0	16.0	7.0	M6
CABLE-MTG2652	125.0	145.0	25.0	66.8	128.0	16.0	7.0	M6
CABLE-MTG2653	135.0	155.0	25.0	66.8	128.0	16.0	7.0	M6
CABLE-MTG2654	75.0	90.0	25.0	66.8	128.0	20.0	9.0	M8
CABLE-MTG2655	90.0	110.0	25.0	66.8	128.0	20.0	9.0	M8
CABLE-MTG2656	105.0	125.0	25.0	66.8	128.0	20.0	9.0	M8
CABLE-MTG2657	110.0	145.0	25.0	66.8	128.0	20.0	9.0	M8

## Dimensional Data Continued

Part No.	A (mm)	B (mm)	C (mm)	D (mm)	E (mm)	F (mm)	Fitment Detail	
							Ø (mm)	M
CABLE-MTG2658	75.0	90.0	25.0	66.8	128.0	20.0	9.0	M8
CABLE-MTG2659	90.0	105.0	25.0	66.8	128.0	20.0	9.0	M8
CABLE-MTG2660	95.0	120.0	25.0	66.8	128.0	20.0	9.0	M8
CABLE-MTG2661	125.0	145.0	25.0	66.8	128.0	20.0	9.0	M8
CABLE-MTG2662	135.0	155.0	25.0	66.8	128.0	20.0	9.0	M8
CABLE-MTG2663	110.0	150.0	25.0	66.8	128.0	20.0	9.0	M8
CABLE-MTG2664	100.0	110.0	25.0	81.9	160.0	25.0	11.0	M10
CABLE-MTG2665	100.0	125.0	25.0	81.9	160.0	25.0	11.0	M10
CABLE-MTG2666	110.0	135.0	25.0	81.9	160.0	25.0	11.0	M10
CABLE-MTG2667	125.0	150.0	25.0	81.9	160.0	25.0	11.0	M10
CABLE-MTG2668	135.0	180.0	25.0	81.9	160.0	25.0	11.0	M10
CABLE-MTG2669	145.0	185.0	25.0	81.9	160.0	25.0	11.0	M10
CABLE-MTG2670	105.0	125.0	30.0	99.0	190.0	30.0	11.0	M10
CABLE-MTG2671	125.0	160.0	30.0	99.0	190.0	30.0	11.0	M10
CABLE-MTG2672	145.0	185.0	30.0	99.0	190.0	30.0	11.0	M10
CABLE-MTG2673	175.0	215.0	30.0	99.0	190.0	30.0	11.0	M10
CABLE-MTG2674	150.0	185.0	40.0	114.3	220.0	40.0	13.0	M12
CABLE-MTG2675	160.0	195.0	40.0	114.3	220.0	40.0	13.0	M12
CABLE-MTG2676	185.0	210.0	50.0	162.0	310.0	50.0	19.0	M18
CABLE-MTG2677	215.0	240.0	50.0	162.0	310.0	50.0	19.0	M18

## Technical Data

Compression ▼



Tension ▲



Shear ▼▲



Compression at 45° ▲



Roll ►

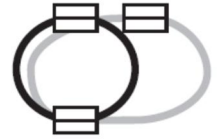

Part No.	Force	Force					
		▼	▲	▼▲	▲	▲	▲
CABLE-MTG2636	Max Static	(kN)	0.30	0.30	0.20	0.25	0.20
		(mm)	3.0	2.1	3.5	5.5	4.5
	Max Dynamic	(kN)	0.84	0.87	0.73	0.73	0.67
		(mm)	11.4	5.6	15.0	20.0	12.5
CABLE-MTG2637	Max Static	(kN)	0.25	0.25	0.15	0.20	0.15
		(mm)	4.1	2.3	7.3	6.3	6.7
	Max Dynamic	(kN)	0.92	1.35	0.71	0.50	0.70
		(mm)	24.3	11.2	24.4	30.0	21.5
CABLE-MTG2638	Max Static	(kN)	0.20	0.20	0.10	0.15	0.10
		(mm)	4.3	3.0	6.8	5.0	6.1
	Max Dynamic	(kN)	0.75	0.81	0.42	0.46	0.34
		(mm)	30.0	11.9	24.3	40.0	22.9

Part No.	Force	Force					
		▼	▲	▼▲	▲	▲	▲
CABLE-MTG2639	Max Static	(kN)	0.17	0.17	0.07	0.10	0.07
		(mm)	8.0	3.5	10.0	6.3	10.0
	Max Dynamic	(kN)	0.56	0.82	0.37	0.28	0.41
		(mm)	43.0	15.3	35.0	56.0	39.3
CABLE-MTG2640	Max Static	(kN)	0.12	0.12	0.06	0.10	0.06
		(mm)	6.0	2.8	10.0	8.8	8.8
	Max Dynamic	(kN)	0.46	0.41	0.35	0.22	0.30
		(mm)	46.5	13.2	40.0	46.8	37.8
CABLE-MTG2641	Max Static	(kN)	0.12	0.12	0.06	0.08	0.06
		(mm)	9.0	8.5	15.1	15.5	16.8
	Max Dynamic	(kN)	0.35	1.20	0.45	0.22	0.39
		(mm)	48.0	40.0	63.2	72.0	60.0

Technical Data Continued

Part No.	Force		▼	▲	▼▲	▲ <sup>45°</sup>	▶
			(kN)	(mm)	(kN)	(mm)	(kN)
CABLE-MTG2642	Max Static	(kN)	0.74	0.74	0.37	0.55	0.37
		(mm)	3.0	2.5	5.0	5.0	6.0
	Max Dynamic	(kN)	2.22	7.25	2.67	1.86	2.59
		(mm)	17.0	12.0	14.3	25.0	20.0
CABLE-MTG2643	Max Static	(kN)	0.62	0.62	0.30	0.46	0.30
		(mm)	4.0	3.5	6.3	7.0	8.0
	Max Dynamic	(kN)	1.85	5.75	2.06	1.15	1.92
		(mm)	23.0	15.0	21.2	35.0	25.0
CABLE-MTG2644	Max Static	(kN)	0.50	0.50	0.25	0.37	0.25
		(mm)	5.0	4.2	8.1	8.2	9.5
	Max Dynamic	(kN)	1.50	4.90	1.73	0.93	1.61
		(mm)	27.0	20.0	26.4	41.0	30.0

Part No.	Force		▼	▲	▼▲	▲ <sup>45°</sup>	▶
			(kN)	(mm)	(kN)	(mm)	(kN)
CABLE-MTG2645	Max Static	(kN)	0.40	0.40	0.20	0.30	0.20
		(mm)	5.8	5.2	9.3	9.5	10.8
	Max Dynamic	(kN)	1.20	4.25	1.45	0.75	1.36
		(mm)	30.0	25.0	33.6	47.0	37.0
CABLE-MTG2646	Max Static	(kN)	0.25	0.25	0.12	0.19	0.12
		(mm)	6.5	6.2	10.2	10.5	2.9
	Max Dynamic	(kN)	0.77	3.67	1.20	0.51	1.12
		(mm)	34.0	45.0	52.7	50.0	55.0
CABLE-MTG2647	Max Static	(kN)	0.25	0.25	0.12	0.18	0.12
		(mm)	9.0	8.2	2.2	15.5	2.9
	Max Dynamic	(kN)	0.75	2.71	0.93	0.47	0.82
		(mm)	48.0	40.0	56.3	72.0	58.0

Part No.	Force		▼	▲	▼▲	▲ <sup>45°</sup>	▶
			(kN)	(mm)	(kN)	(mm)	(kN)
CABLE-MTG2648	Max Static	(kN)	0.58	0.58	0.38	0.50	0.38
		(mm)	5.0	1.5	8.2	7.5	11.0
	Max Dynamic	(kN)	2.50	4.00	1.20	1.23	1.74
		(mm)	35.8	6.7	22.0	41.0	30.5
CABLE-MTG2649	Max Static	(kN)	0.45	0.45	0.25	0.38	0.25
		(mm)	5.0	3.0	9.5	10.0	10.0
	Max Dynamic	(kN)	1.68	0.85	1.20	0.93	1.06
		(mm)	35.0	6.3	33.0	54.5	33.0
CABLE-MTG2650	Max Static	(kN)	0.44	0.44	0.20	0.25	0.20
		(mm)	10.0	5.8	13.0	9.3	13.0
	Max Dynamic	(kN)	1.54	1.35	0.79	0.79	0.71
		(mm)	58.0	16.9	38.8	63.5	40.5

Part No.	Force		▼	▲	▼▲	▲ <sup>45°</sup>	▶
			(kN)	(mm)	(kN)	(mm)	(kN)
CABLE-MTG2651	Max Static	(kN)	0.38	0.38	0.18	0.20	0.18
		(mm)	11.0	2.0	12.5	9.0	16.3
	Max Dynamic	(kN)	1.42	1.80	1.16	0.67	0.94
		(mm)	75.0	47.5	62.5	88.0	63.5
CABLE-MTG2652	Max Static	(kN)	0.28	0.28	0.14	0.20	0.14
		(mm)	14.5	10.0	26.0	26.0	28.8
	Max Dynamic	(kN)	0.84	2.21	0.71	0.50	0.64
		(mm)	82.0	35.0	66.5	122.0	72.0
CABLE-MTG2653	Max Static	(kN)	0.25	0.25	0.13	0.19	0.13
		(mm)	16.0	11.0	30.0	29.0	32.0
	Max Dynamic	(kN)	0.75	1.98	0.65	0.45	0.56
		(mm)	90.0	40.0	77.1	137.0	80.0

Part No.	Force		▼	▲	▼▲	▲ <sup>45°</sup>	▶
			(kN)	(mm)	(kN)	(mm)	(kN)
CABLE-MTG2654	Max Static	(kN)	1.48	1.48	0.74	1.10	0.74
		(mm)	7.0	5.0	9.1	11.5	13.0
	Max Dynamic	(kN)	4.40	12.2	4.10	2.65	3.80
		(mm)	37.0	20.0	28.4	55.0	35.0
CABLE-MTG2655	Max Static	(kN)	1.08	1.08	0.54	0.80	0.54
		(mm)	9.0	6.5	15.1	16.0	17.5
	Max Dynamic	(kN)	3.20	8.95	2.90	1.92	2.70
		(mm)	50.0	28.0	42.6	75.0	47.0

Part No.	Force		▼	▲	▼▲	▲ <sup>45°</sup>	▶
			(kN)	(mm)	(kN)	(mm)	(kN)
CABLE-MTG2656	Max Static	(kN)	0.89	0.89	0.44	0.67	0.44
		(mm)	11.5	8.0	20.0	21.0	23.0
	Max Dynamic	(kN)	2.65	6.99	2.19	1.57	2.04
		(mm)	65.0	30.0	54.3	98.0	58.0
CABLE-MTG2657	Max Static	(kN)	0.67	0.67	0.33	0.50	0.33
		(mm)	12.5	10.0	22.1	22.5	24.0
	Max Dynamic	(kN)	2.00	6.27	2.08	1.25	1.87
		(mm)	68.0	45.0	67.3	102.0	70.0

Part No.	Force		▼	▲	▼▲	▲ <sup>45°</sup>	▶
			(kN)	(mm)	(kN)	(mm)	(kN)
CABLE-MTG2658	Max Static	(kN)	1.75	1.75	0.63	1.50	0.63
		(mm)	6.6	3.7	4.8	10.0	5.2
	Max Dynamic	(kN)	5.20	6.50	3.33	3.88	1.93
		(mm)	25.0	10.3	18.4	43.0	15.4
CABLE-MTG2659	Max Static	(kN)	1.50	1.50	0.63	1.00	0.63
		(mm)	8.3	5.0	8.3	8.8	10.4
	Max Dynamic	(kN)	12.2	17.0	5.30	4.85	2.75
		(mm)	53.0	18.3	27.5	40.0	21.7
CABLE-MTG2660	Max Static	(kN)	1.25	1.25	0.56	0.88	0.56
		(mm)	10.0	5.0	9.0	10.8	10.3
	Max Dynamic	(kN)	3.73	3.73	1.55	1.88	0.83
		(mm)	40.0	14.0	20.7	39.5	15.5

Part No.	Force		▼	▲	▼▲	▲ <sup>45°</sup>	▶
			(kN)	(mm)	(kN)	(mm)	(kN)
CABLE-MTG2661	Max Static	(kN)	1.18	1.18	0.55	0.83	0.55
		(mm)	13.5	9.0	23.1	25.0	25.0
	Max Dynamic	(kN)	3.55	2.38	3.25	2.13	2.80
		(mm)	75.0	23.0	70.0	115.0	65.0
CABLE-MTG2662	Max Static	(kN)	1.03	1.03	0.55	0.78	0.55
		(mm)	15.5	10.5	8.0	28.0	30.0
	Max Dynamic	(kN)	3.08	8.25	2.65	1.85	2.40
		(mm)	85.0	40.0	82.0	130.0	78.0
CABLE-MTG2663	Max Static	(kN)	0.83	0.83	0.35	0.63	0.35
		(mm)	17.5	9.0	12.0	16.3	11.5
	Max Dynamic	(kN)	2.75	2.38	1.13	1.28	0.69
		(mm)	70.0	23.0	38.5	52.5	24.8

Technical Data Continued

Part No.	Force		▼	▲	▼▲	▲ <sup>45°</sup>	▶
			(kN)	(mm)	(kN)	(mm)	(kN)
CABLE-MTG2664	Max Static	(kN)	2.50	2.50	1.25	2.25	1.25
		(mm)	5.8	2.5	6.0	7.5	9.0
	Max Dynamic	(kN)	6.45	16.9	3.32	5.50	2.15
		(mm)	21.3	15.0	18.0	35.0	18.0
CABLE-MTG2665	Max Static	(kN)	2.50	2.50	1.25	2.00	1.25
		(mm)	7.5	4.5	8.0	10.0	9.3
	Max Dynamic	(kN)	10.6	14.3	2.75	5.10	4.17
		(mm)	51.0	20.5	21.7	50.0	30.0
CABLE-MTG2666	Max Static	(kN)	2.25	2.25	1.12	1.75	1.12
		(mm)	10.0	8.3	11.0	12.5	13.8
	Max Dynamic	(kN)	6.60	8.55	3.00	4.05	3.89
		(mm)	43.0	25.0	32.5	51.0	40.0

Part No.	Force		▼	▲	▼▲	▲ <sup>45°</sup>	▶
			(kN)	(mm)	(kN)	(mm)	(kN)
CABLE-MTG2667	Max Static	(kN)	2.10	2.10	1.05	1.62	1.05
		(mm)	11.0	10.0	19.1	19.0	20.5
	Max Dynamic	(kN)	6.31	22.0	7.77	3.97	7.20
		(mm)	60.0	48.0	78.2	90.0	70.0
CABLE-MTG2668	Max Static	(kN)	1.60	1.60	0.81	1.21	0.81
		(mm)	13.5	12.5	24.7	24.5	26.0
	Max Dynamic	(kN)	4.85	17.5	5.75	3.07	5.45
		(mm)	75.0	62.0	99.0	110.0	90.0
CABLE-MTG2669	Max Static	(kN)	1.55	1.55	0.77	1.17	0.77
		(mm)	15.5	13.5	27.1	28.0	29.0
	Max Dynamic	(kN)	4.67	15.6	5.05	2.92	4.82
		(mm)	85.0	62.0	103.0	125.0	95.0

Part No.	Force		▼	▲	▼▲	▲ <sup>45°</sup>	▶
			(kN)	(mm)	(kN)	(mm)	(kN)
CABLE-MTG2670	Max Static	(kN)	5.00	5.00	2.50	3.74	2.50
		(mm)	7.0	6.0	12.0	12.5	13.5
	Max Dynamic	(kN)	15.0	48.3	17.3	9.27	16.8
		(mm)	40.0	28.0	31.0	60.0	42.0
CABLE-MTG2671	Max Static	(kN)	3.20	3.20	1.60	2.40	1.60
		(mm)	10.5	9.5	19.0	19.0	20.5
	Max Dynamic	(kN)	9.60	33.8	11.4	6.04	11.0
		(mm)	58.0	47.0	60.0	90.0	68.0

Part No.	Force		▼	▲	▼▲	▲ <sup>45°</sup>	▶
			(kN)	(mm)	(kN)	(mm)	(kN)
CABLE-MTG2672	Max Static	(kN)	2.55	2.55	1.27	1.92	1.27
		(mm)	14.0	12.5	25.0	25.5	26.5
	Max Dynamic	(kN)	7.65	26.2	8.47	4.80	8.21
		(mm)	75.0	60.0	82.0	115.0	90.0
CABLE-MTG2673	Max Static	(kN)	2.05	2.05	1.02	1.55	1.02
		(mm)	19.0	15.5	33.0	35.0	35.0
	Max Dynamic	(kN)	6.17	19.5	6.25	3.80	5.95
		(mm)	105.0	68.0	103.0	155.0	110.0

Part No.	Force		▼	▲	▼▲	▲ <sup>45°</sup>	▶
			(kN)	(mm)	(kN)	(mm)	(kN)
CABLE-MTG2674	Max Static	(kN)	5.00	5.00	1.50	3.75	1.50
		(mm)	9.0	8.8	6.0	11.5	5.8
	Max Dynamic	(kN)	14.4	16.9	4.00	8.75	5.15
		(mm)	55.0	29.0	24.4	57.0	36.0

Part No.	Force		▼	▲	▼▲	▲ <sup>45°</sup>	▶
			(kN)	(mm)	(kN)	(mm)	(kN)
CABLE-MTG2675	Max Static	(kN)	5.00	5.00	2.00	2.50	2.00
		(mm)	13.8	10.0	13.8	12.5	14.0
	Max Dynamic	(kN)	13.0	18.0	5.50	6.95	7.50
		(mm)	64.5	40.0	50.0	55.0	60.0

Part No.	Force		▼	▲	▼▲	▲ <sup>45°</sup>	▶
			(kN)	(mm)	(kN)	(mm)	(kN)
CABLE-MTG2676	Max Static	(kN)	9.25	9.25	4.60	6.90	4.60
		(mm)	13.0	11.0	22.6	23.0	24.0
	Max Dynamic	(kN)	27.7	98.9	33.3	17.3	32.5
		(mm)	70.0	52.0	66.0	10.0	77.0

Part No.	Force		▼	▲	▼▲	▲ <sup>45°</sup>	▶
			(kN)	(mm)	(kN)	(mm)	(kN)
CABLE-MTG2677	Max Static	(kN)	8.10	8.10	4.05	6.07	4.05
		(mm)	20.0	13.5	34.1	35.0	36.0
	Max Dynamic	(kN)	24.3	67.9	22.0	14.6	21.4
		(mm)	105.0	53.0	86.0	155.0	95.0

### Cable Mounts (Type 2)

### Fitment Options

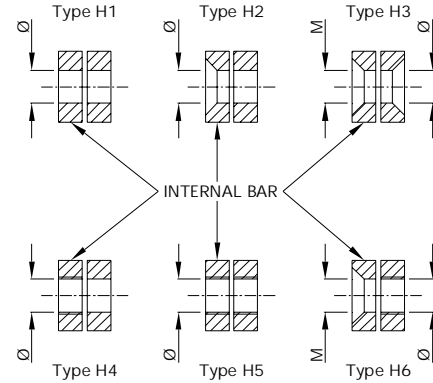
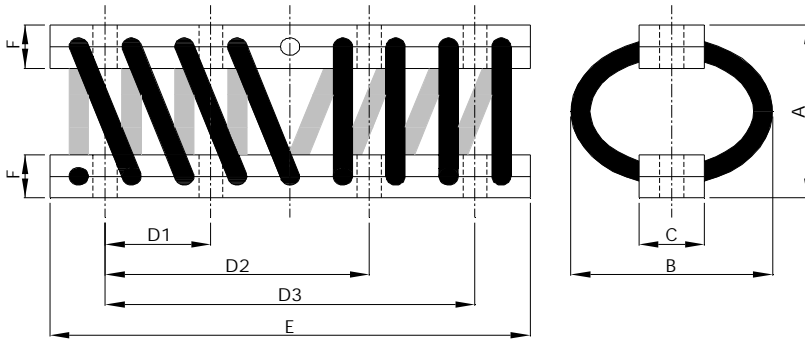

### Dimensional Data

Part No.	A (mm)	B (mm)	C (mm)	D1 (mm)	D2 (mm)	D3 (mm)	E (mm)	F (mm)	Fitment Detail	
									Ø (mm)	M
CABLE-MTG2678	50.0	60.0	16.0	131.0	—	—	146.0	13.0	7.0	M6
CABLE-MTG2679	60.0	70.0	16.0	131.0	—	—	146.0	13.0	7.0	M6
CABLE-MTG2680	70.0	80.0	16.0	131.0	—	—	146.0	13.0	7.0	M6
CABLE-MTG2681	80.0	90.0	16.0	131.0	—	—	146.0	13.0	7.0	M6
CABLE-MTG2682	90.0	100.0	16.0	131.0	—	—	146.0	13.0	7.0	M6
CABLE-MTG2683	85.0	110.0	16.0	131.0	—	—	146.0	13.0	7.0	M6
CABLE-MTG2684	50.0	60.0	16.0	131.0	—	—	146.0	13.0	7.0	M6
CABLE-MTG2685	55.0	65.0	16.0	131.0	—	—	146.0	13.0	7.0	M6
CABLE-MTG2686	60.0	70.0	16.0	131.0	—	—	146.0	13.0	7.0	M6
CABLE-MTG2687	65.0	80.0	16.0	131.0	—	—	146.0	13.0	7.0	M6
CABLE-MTG2688	70.0	100.0	16.0	131.0	—	—	146.0	13.0	7.0	M6
CABLE-MTG2689	80.0	110.0	16.0	131.0	—	—	146.0	13.0	7.0	M6
CABLE-MTG2690	75.0	90.0	25.0	44.5	111.5	156.0	216.0	16.0	7.0	M6
CABLE-MTG2691	90.0	110.0	25.0	44.5	111.5	156.0	216.0	16.0	7.0	M6
CABLE-MTG2692	100.0	115.0	25.0	44.5	111.5	156.0	216.0	16.0	7.0	M6
CABLE-MTG2693	110.0	135.0	25.0	44.5	111.5	156.0	216.0	16.0	7.0	M6
CABLE-MTG2694	125.0	145.0	25.0	44.5	111.5	156.0	216.0	16.0	7.0	M6
CABLE-MTG2695	135.0	155.0	25.0	44.5	111.5	156.0	216.0	16.0	7.0	M6
CABLE-MTG2696	75.0	90.0	25.0	44.5	111.5	156.0	216.0	16.0	7.0	M6
CABLE-MTG2697	90.0	110.0	25.0	44.5	111.5	156.0	216.0	16.0	7.0	M6
CABLE-MTG2698	105.0	125.0	25.0	44.5	111.5	156.0	216.0	16.0	7.0	M6
CABLE-MTG2699	110.0	145.0	25.0	44.5	111.5	156.0	216.0	16.0	7.0	M6
CABLE-MTG2700	125.0	145.0	25.0	44.5	111.5	156.0	216.0	16.0	7.0	M6
CABLE-MTG2701	135.0	155.0	25.0	44.5	111.5	156.0	216.0	16.0	7.0	M6
CABLE-MTG2702	75.0	90.0	25.0	44.5	111.5	156.0	216.0	20.0	9.0	M8
CABLE-MTG2703	90.0	105.0	25.0	44.5	111.5	156.0	216.0	20.0	9.0	M8
CABLE-MTG2704	95.0	120.0	25.0	44.5	111.5	156.0	216.0	20.0	9.0	M8
CABLE-MTG2705	125.0	145.0	25.0	44.5	111.5	156.0	216.0	20.0	9.0	M8
CABLE-MTG2706	135.0	155.0	25.0	44.5	111.5	156.0	216.0	20.0	9.0	M8

## Dimensional Data Continued

Part No.	A (mm)	B (mm)	C (mm)	D1 (mm)	D2 (mm)	D3 (mm)	E (mm)	F (mm)	Fitment Detail	
									Ø (mm)	M
CABLE-MTG2707	110.0	150.0	25.0	44.5	111.5	156.0	216.0	20.0	9.0	M8
CABLE-MTG2708	100.0	110.0	25.0	54.5	136.5	191.0	267.0	25.0	11.0	M10
CABLE-MTG2709	100.0	125.0	25.0	54.5	136.5	191.0	267.0	25.0	11.0	M10
CABLE-MTG2710	110.0	135.0	25.0	54.5	136.5	191.0	267.0	25.0	11.0	M10
CABLE-MTG2711	125.0	150.0	25.0	54.5	136.5	191.0	267.0	25.0	11.0	M10
CABLE-MTG2712	135.0	180.0	25.0	54.5	136.5	191.0	267.0	25.0	11.0	M10
CABLE-MTG2713	145.0	185.0	25.0	54.5	136.5	191.0	267.0	25.0	11.0	M10
CABLE-MTG2714	105.0	125.0	30.0	66.0	165.0	231.0	320.0	31.0	11.0	M10
CABLE-MTG2715	125.0	160.0	30.0	66.0	165.0	231.0	320.0	31.0	11.0	M10
CABLE-MTG2716	145.0	185.0	30.0	66.0	165.0	231.0	320.0	31.0	11.0	M10
CABLE-MTG2717	175.0	215.0	30.0	66.0	165.0	231.0	320.0	31.0	11.0	M10
CABLE-MTG2718	150.0	185.0	40.0	76.0	191.0	267.0	370.0	41.0	13.0	M12
CABLE-MTG2719	160.0	195.0	40.0	76.0	191.0	267.0	370.0	41.0	13.0	M12
CABLE-MTG2720	185.0	210.0	50.0	108.0	270.0	378.0	520.0	51.0	19.0	M18
CABLE-MTG2721	215.0	240.0	50.0	108.0	270.0	378.0	520.0	51.0	19.0	M18

## Technical Data

Compression ▼



Tension ▲



Shear ▼▲



Compression at 45° ▲



Roll ►

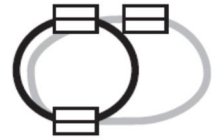

Part No.	Force	Force					
		▼	▲	▼▲	▲	45°	►
CABLE-MTG2678	Max Static	(kN)	0.60	0.60	0.40	0.50	0.40
		(mm)	3.0	2.1	3.5	5.5	4.5
	Max Dynamic	(kN)	1.68	1.74	1.45	1.47	1.35
		(mm)	11.4	5.6	15.0	20.0	12.5
CABLE-MTG2679	Max Static	(kN)	0.50	0.50	0.30	0.40	0.30
		(mm)	4.1	2.3	7.3	6.3	6.7
	Max Dynamic	(kN)	1.85	2.70	1.52	1.01	1.40
		(mm)	24.3	11.2	24.4	30.0	21.5
CABLE-MTG2680	Max Static	(kN)	0.40	0.40	0.20	0.30	0.20
		(mm)	4.3	3.0	6.8	5.0	6.1
	Max Dynamic	(kN)	1.50	1.63	0.85	0.92	0.69
		(mm)	30.0	11.9	24.3	40.0	22.9

Part No.	Force	Force					
		▼	▲	▼▲	▲	45°	►
CABLE-MTG2681	Max Static	(kN)	0.35	0.35	0.15	0.20	0.15
		(mm)	8.0	3.5	10.0	6.3	10.0
	Max Dynamic	(kN)	1.12	1.64	0.75	0.57	0.84
		(mm)	43.0	15.3	35.0	56.0	39.3
CABLE-MTG2682	Max Static	(kN)	0.25	0.25	0.13	0.20	0.13
		(mm)	6.0	2.8	10.0	8.8	8.8
	Max Dynamic	(kN)	0.93	0.83	0.70	0.46	0.60
		(mm)	46.5	13.2	40.0	46.8	37.8
CABLE-MTG2683	Max Static	(kN)	0.24	0.24	0.12	0.18	0.12
		(mm)	9.0	8.5	15.1	15.5	16.8
	Max Dynamic	(kN)	0.70	2.55	0.90	0.45	0.79
		(mm)	48.0	40.0	63.2	72.0	60.0



Technical Data Continued

Part No.	Force		▼	▲	▼▲	▲45°	▶
	CABLE-MTG2684	Max Static	(kN)	1.48	1.48	0.74	1.10
(mm)			3.0	2.5	5.0	5.0	6.0
	Max Dynamic	(kN)	4.44	14.5	5.35	2.75	5.18
		(mm)	17.0	12.0	14.3	25.0	20.0
CABLE-MTG2685	Max Static	(kN)	1.25	1.25	0.62	0.93	0.62
		(mm)	4.0	3.5	6.3	7.0	8.0
	Max Dynamic	(kN)	3.70	11.6	4.13	2.30	3.85
		(mm)	23.0	15.0	21.2	35.0	25.0
CABLE-MTG2686	Max Static	(kN)	1.00	1.00	0.50	0.75	0.50
		(mm)	5.0	4.2	8.1	8.2	9.5
	Max Dynamic	(kN)	3.00	9.81	3.47	1.86	3.23
		(mm)	27.0	20.0	26.4	41.0	30.0

Part No.	Force		▼	▲	▼▲	▲45°	▶
	CABLE-MTG2687	Max Static	(kN)	0.80	0.80	0.40	0.60
(mm)			5.8	5.2	9.3	9.5	10.8
	Max Dynamic	(kN)	2.40	8.50	2.91	1.50	2.73
		(mm)	30.0	25.0	33.6	47.0	37.0
CABLE-MTG2688	Max Static	(kN)	0.52	0.52	0.26	0.39	0.03
		(mm)	6.5	6.2	10.2	10.5	2.9
	Max Dynamic	(kN)	1.55	7.35	2.40	1.02	2.25
		(mm)	34.0	45.0	52.7	50.0	55.0
CABLE-MTG2689	Max Static	(kN)	0.50	0.50	0.03	0.38	0.03
		(mm)	9.0	8.2	2.2	15.5	2.9
	Max Dynamic	(kN)	1.50	5.42	1.87	0.95	1.65
		(mm)	48.0	40.0	56.3	72.0	58.0

Part No.	Force		▼	▲	▼▲	▲45°	▶
	CABLE-MTG2690	Max Static	(kN)	1.15	1.15	0.75	1.00
(mm)			5.0	1.5	8.2	7.5	11.0
	Max Dynamic	(kN)	5.00	8.00	2.40	2.55	3.45
		(mm)	35.8	6.7	22.0	41.0	30.5
CABLE-MTG2691	Max Static	(kN)	0.90	0.90	0.50	0.75	0.50
		(mm)	5.0	3.0	9.5	10.0	10.0
	Max Dynamic	(kN)	3.35	1.70	2.40	1.85	2.13
		(mm)	35.0	6.3	33.0	54.5	33.0
CABLE-MTG2692	Max Static	(kN)	0.88	0.88	0.40	0.50	0.40
		(mm)	10.0	5.8	13.0	9.3	13.0
	Max Dynamic	(kN)	3.08	2.70	1.56	1.57	1.42
		(mm)	58.0	16.9	38.8	63.5	40.5

Part No.	Force		▼	▲	▼▲	▲45°	▶
	CABLE-MTG2693	Max Static	(kN)	0.75	0.75	0.35	0.40
(mm)			11.0	2.0	12.5	9.0	16.3
	Max Dynamic	(kN)	2.83	3.60	2.33	1.33	1.88
		(mm)	75.0	47.5	62.5	88.0	63.5
CABLE-MTG2694	Max Static	(kN)	0.56	0.56	0.28	0.40	0.28
		(mm)	14.5	10.0	26.0	26.0	28.8
	Max Dynamic	(kN)	1.68	4.42	1.42	1.00	1.27
		(mm)	82.0	35.0	66.5	122.0	72.0
CABLE-MTG2695	Max Static	(kN)	0.50	0.50	0.25	0.38	0.25
		(mm)	16.0	11.0	30.0	29.0	32.0
	Max Dynamic	(kN)	1.50	3.95	1.30	0.90	1.12
		(mm)	90.0	40.0	77.1	137.0	80.0

Part No.	Force		▼	▲	▼▲	▲45°	▶
	CABLE-MTG2696	Max Static	(kN)	2.95	2.95	1.48	2.20
(mm)			7.0	5.0	9.1	11.5	13.0
	Max Dynamic	(kN)	8.80	24.3	8.20	5.30	7.60
		(mm)	37.0	20.0	28.4	55.0	35.0
CABLE-MTG2697	Max Static	(kN)	2.15	2.15	1.08	1.60	1.08
		(mm)	9.0	6.5	15.1	16.0	17.5
	Max Dynamic	(kN)	6.40	17.9	5.81	3.85	5.40
		(mm)	50.0	28.0	42.6	75.0	47.0
CABLE-MTG2698	Max Static	(kN)	1.78	1.78	0.89	1.34	0.89
		(mm)	11.5	8.0	20.0	21.0	23.0
	Max Dynamic	(kN)	5.30	14.0	4.38	3.15	4.08
		(mm)	65.0	30.0	54.3	98.0	58.0

Part No.	Force		▼	▲	▼▲	▲45°	▶
	CABLE-MTG2699	Max Static	(kN)	1.35	1.35	0.67	1.00
(mm)			12.5	10.0	22.1	22.5	24.0
	Max Dynamic	(kN)	4.00	12.6	4.17	2.50	3.75
		(mm)	68.0	45.0	67.3	102.0	70.0
CABLE-MTG2700	Max Static	(kN)	1.35	1.35	0.68	1.02	0.68
		(mm)	15.0	10.0	25.1	27.0	29.0
	Max Dynamic	(kN)	4.05	10.7	3.36	2.40	3.08
		(mm)	82.0	40.0	73.0	125.0	75.0
CABLE-MTG2701	Max Static	(kN)	1.20	1.20	0.61	0.90	0.61
		(mm)	11.0	11.0	30.1	30.0	32.0
	Max Dynamic	(kN)	3.62	9.55	2.90	2.15	2.72
		(mm)	90.0	40.0	78.2	140.0	80.0

Part No.	Force		▼	▲	▼▲	▲45°	▶
	CABLE-MTG2702	Max Static	(kN)	3.50	3.50	1.25	3.00
(mm)			6.6	3.7	4.8	10.0	5.2
	Max Dynamic	(kN)	10.4	13.0	6.65	7.75	3.85
		(mm)	25.0	10.3	18.4	43.0	15.4
CABLE-MTG2703	Max Static	(kN)	3.00	3.00	1.25	2.00	1.25
		(mm)	8.3	5.0	8.3	8.8	10.4
	Max Dynamic	(kN)	12.2	17.0	5.30	4.85	2.75
		(mm)	53.0	18.3	27.5	40.0	21.7
CABLE-MTG2704	Max Static	(kN)	2.50	2.50	1.13	1.75	1.13
		(mm)	10.0	5.0	9.0	10.8	10.3
	Max Dynamic	(kN)	7.45	7.50	3.10	3.75	1.65
		(mm)	40.0	14.0	20.7	39.5	15.5

Part No.	Force		▼	▲	▼▲	▲45°	▶
	CABLE-MTG2705	Max Static	(kN)	2.35	2.35	1.10	1.75
(mm)			13.5	9.0	23.1	25.0	25.0
	Max Dynamic	(kN)	7.10	4.75	6.50	4.25	5.60
		(mm)	75.0	23.0	70.0	115.0	65.0
CABLE-MTG2706	Max Static	(kN)	2.05	2.05	1.00	1.55	1.00
		(mm)	15.5	10.5	8.0	28.0	30.0
	Max Dynamic	(kN)	6.15	16.5	5.30	3.70	4.80
		(mm)	85.0	40.0	82.0	130.0	78.0
CABLE-MTG2707	Max Static	(kN)	1.75	1.75	0.70	1.25	0.70
		(mm)	17.5	9.0	12.0	16.3	11.5
	Max Dynamic	(kN)	5.50	4.75	2.25	2.55	1.38
		(mm)	70.0	23.0	38.5	52.5	24.8

Technical Data Continued

Part No.	Force		▼	▲	▼▲	▲ <sup>45°</sup>	▶
	CABLE-MTG2708	Max Static	(kN)	5.00	5.00	2.50	4.50
(mm)			5.8	2.5	6.0	7.5	9.0
	Max Dynamic	(kN)	12.9	33.8	6.65	11.0	4.30
		(mm)	21.3	15.0	18.0	35.0	18.0
CABLE-MTG2709	Max Static	(kN)	5.00	5.00	2.50	4.00	2.50
		(mm)	7.5	4.5	8.0	10.0	9.3
	Max Dynamic	(kN)	21.3	28.8	5.50	10.2	8.35
		(mm)	51.0	20.5	21.7	50.0	30.0
CABLE-MTG2710	Max Static	(kN)	4.50	4.50	2.25	3.50	2.25
		(mm)	10.0	8.3	11.0	12.5	13.8
	Max Dynamic	(kN)	13.3	17.1	6.00	8.10	7.78
		(mm)	43.0	25.0	32.5	51.0	40.0

Part No.	Force		▼	▲	▼▲	▲ <sup>45°</sup>	▶
	CABLE-MTG2711	Max Static	(kN)	4.20	4.20	2.10	3.15
(mm)			11.0	10.0	19.1	19.0	20.5
	Max Dynamic	(kN)	12.6	44.0	15.5	7.95	14.4
		(mm)	60.0	48.0	78.2	90.0	70.0
CABLE-MTG2712	Max Static	(kN)	3.20	3.20	1.62	2.42	1.62
		(mm)	13.5	12.5	24.7	24.5	26.0
	Max Dynamic	(kN)	9.70	35.0	11.5	6.15	10.9
		(mm)	75.0	62.0	99.0	110.0	90.0
CABLE-MTG2713	Max Static	(kN)	3.10	3.10	1.55	2.35	1.55
		(mm)	15.5	13.5	27.1	28.0	29.0
	Max Dynamic	(kN)	9.35	31.2	10.1	5.85	9.65
		(mm)	85.0	62.0	103.0	125.0	95.0

Part No.	Force		▼	▲	▼▲	▲ <sup>45°</sup>	▶
	CABLE-MTG2714	Max Static	(kN)	10.0	10.0	5.00	7.48
(mm)			7.0	6.0	12.0	12.5	13.5
	Max Dynamic	(kN)	29.9	96.7	34.6	18.6	33.5
		(mm)	40.0	28.0	31.0	60.0	42.0
CABLE-MTG2715	Max Static	(kN)	6.40	6.40	3.20	4.80	3.20
		(mm)	10.5	9.5	19.0	19.0	20.5
	Max Dynamic	(kN)	19.2	67.5	22.7	12.1	22.0
		(mm)	58.0	47.0	60.0	90.0	68.0

Part No.	Force		▼	▲	▼▲	▲ <sup>45°</sup>	▶
	CABLE-MTG2716	Max Static	(kN)	5.10	5.10	2.55	3.85
(mm)			14.0	12.5	25.0	25.5	26.5
	Max Dynamic	(kN)	15.3	52.3	17.0	9.60	16.4
		(mm)	75.0	60.0	82.0	115.0	90.0
CABLE-MTG2717	Max Static	(kN)	4.10	4.10	2.05	3.10	2.05
		(mm)	19.0	15.5	33.0	35.0	35.0
	Max Dynamic	(kN)	12.4	39.0	12.5	7.60	11.9
		(mm)	105.0	68.0	103.0	155.0	110.0

Part No.	Force		▼	▲	▼▲	▲ <sup>45°</sup>	▶
	CABLE-MTG2718	Max Static	(kN)	10.0	10.0	3.00	7.50
(mm)			9.0	8.8	6.0	11.5	5.8
	Max Dynamic	(kN)	28.8	33.8	8.00	17.5	10.3
		(mm)	55.0	29.0	24.4	57.0	36.0

Part No.	Force		▼	▲	▼▲	▲ <sup>45°</sup>	▶
	CABLE-MTG2719	Max Static	(kN)	10.0	10.0	4.00	5.00
(mm)			13.8	10.0	13.8	12.5	14.0
	Max Dynamic	(kN)	26.0	36.0	11.0	13.9	15.0
		(mm)	64.5	40.0	50.0	55.0	60.0

Part No.	Force		▼	▲	▼▲	▲ <sup>45°</sup>	▶
	CABLE-MTG2720	Max Static	(kN)	18.5	18.5	9.20	13.8
(mm)			13.0	11.0	22.6	23.0	24.0
	Max Dynamic	(kN)	55.3	187.7	66.5	34.6	65.0
		(mm)	70.0	52.0	66.0	10.0	77.0

Part No.	Force		▼	▲	▼▲	▲ <sup>45°</sup>	▶
	CABLE-MTG2721	Max Static	(kN)	16.2	16.2	8.10	12.2
(mm)			20.0	13.5	34.1	35.0	36.0
	Max Dynamic	(kN)	48.6	135.8	43.9	29.3	42.8
		(mm)	105.0	53.0	86.0	155.0	95.0



### Cable Mounts (Type 3)

### Fitment Options

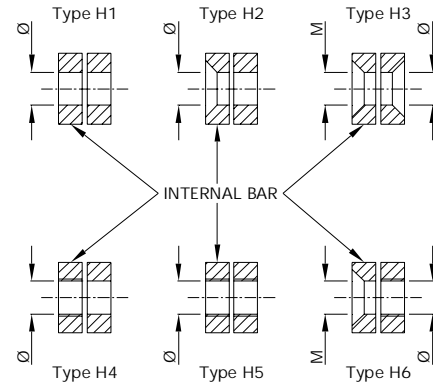
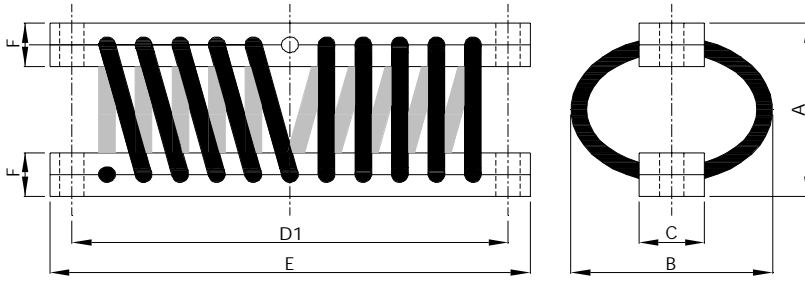

### Dimensional Data

Part No.	A (mm)	B (mm)	C (mm)	D1 (mm)	E (mm)	F (mm)	Fitment Detail	
							Ø (mm)	M
CABLE-MTG2725	35.0	40.0	15.0	114.0	127.0	11.0	7.0	M6
CABLE-MTG2726	40.0	45.0	15.0	114.0	127.0	11.0	7.0	M6
CABLE-MTG2727	45.0	55.0	15.0	114.0	127.0	11.0	7.0	M6
CABLE-MTG2728	55.0	65.0	15.0	114.0	127.0	11.0	7.0	M6
CABLE-MTG2729	65.0	75.0	15.0	114.0	127.0	11.0	7.0	M6
CABLE-MTG2730	85.0	95.0	15.0	114.0	127.0	11.0	7.0	M6

### Technical Data

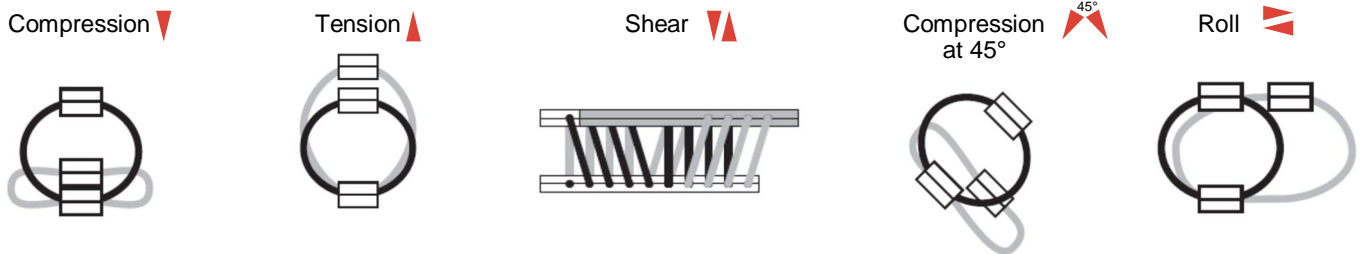

Part No.	Force	Force					
		▼	▲	▼▲	▲45°	▶	
CABLE-MTG2725	Max Static	(kN)	0.91	0.91	0.45	0.68	0.45
		(mm)	2.0	1.5	3.0	3.5	4.0
CABLE-MTG2726	Max Dynamic	(kN)	2.75	6.80	2.50	1.60	2.20
		(mm)	12.0	5.0	11.3	18.0	10.0
CABLE-MTG2727	Max Static	(kN)	0.74	0.74	0.37	0.56	0.37
		(mm)	2.5	1.8	4.0	5.0	5.5
CABLE-MTG2728	Max Dynamic	(kN)	2.20	5.60	1.92	1.30	1.78
		(mm)	15.0	7.0	16.7	25.0	15.0
CABLE-MTG2729	Max Static	(kN)	0.60	0.60	0.25	0.40	0.25
		(mm)	3.8	2.5	5.5	4.3	5.2
CABLE-MTG2730	Max Dynamic	(kN)	1.61	1.60	0.78	1.08	0.61
		(mm)	18.4	16.0	14.6	24.4	11.7

### Cable Mounts (Type 4)

### Fitment Options

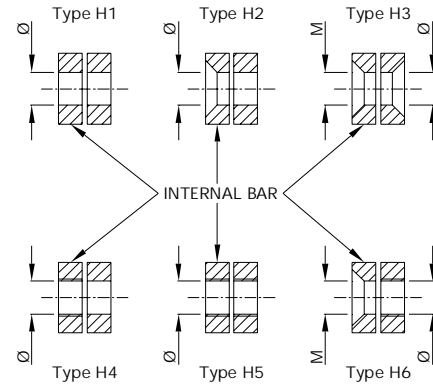
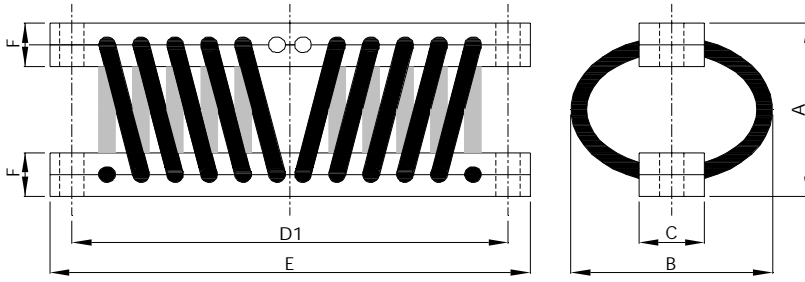

### Dimensional Data

Part No.	A (mm)	B (mm)	C (mm)	D1 (mm)	E (mm)	F (mm)	Fitment Detail	
							$\phi$ (mm)	M
CABLE-MTG2731	20.0	25.0	10.0	68.5	80.0	5.0	5.0	M4
CABLE-MTG2732	25.0	35.0	10.0	68.5	80.0	5.0	5.0	M4
CABLE-MTG2733	35.0	40.0	10.0	68.5	80.0	5.0	5.0	M4
CABLE-MTG2734	40.0	45.0	10.0	68.5	80.0	5.0	5.0	M4
CABLE-MTG2735	20.0	30.0	12.5	100.0	112.0	6.0	6.0	M5
CABLE-MTG2736	25.0	30.0	12.5	100.0	112.0	6.0	6.0	M5
CABLE-MTG2737	35.0	40.0	12.5	100.0	112.0	6.0	6.0	M5
CABLE-MTG2738	40.0	45.0	12.5	100.0	112.0	6.0	6.0	M5
CABLE-MTG2739	30.0	35.0	14.0	114.0	127.0	8.0	6.0	M5
CABLE-MTG2740	35.0	40.0	14.0	114.0	127.0	8.0	6.0	M5
CABLE-MTG2741	40.0	45.0	14.0	114.0	127.0	8.0	6.0	M5
CABLE-MTG2742	45.0	50.0	14.0	114.0	127.0	8.0	6.0	M5
CABLE-MTG2743	30.0	35.0	14.0	114.0	127.0	8.0	6.0	M5
CABLE-MTG2744	35.0	40.0	14.0	114.0	127.0	8.0	6.0	M5
CABLE-MTG2745	40.0	45.0	14.0	114.0	127.0	8.0	6.0	M5
CABLE-MTG2746	45.0	50.0	14.0	114.0	127.0	8.0	6.0	M5

### Technical Data

Compression ▼



Tension ▲



Shear ▼▲



Compression at 45° ▲



Roll ▼▲

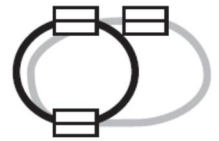

Part No.	Force		▼	▲	▼▲	▲	▼▲
	(N)	(mm)					
CABLE-MTG2731	Max Static	(N)	35	35	25	35	25
		(mm)	1.5	0.7	2.2	2.9	2.9
	Max Dynamic	(N)	110	200	160	60	160
		(mm)	7.5	3.5	6.8	9.0	8.8
CABLE-MTG2732	Max Static	(N)	20	20	10	15	10
		(mm)	2.2	2.2	2.3	4.0	4.1
	Max Dynamic	(N)	50	78	43	27	40
		(mm)	10.5	5.0	9.5	15.4	12.0

Part No.	Force		▼	▲	▼▲	▲	▼▲
	(N)	(mm)					
CABLE-MTG2733	Max Static	(N)	15	15	8	10	8
		(mm)	3.7	2.5	7.0	7.0	8.5
	Max Dynamic	(N)	40	98	30	25	28
		(mm)	24.0	8.0	14.6	35.0	20.0
CABLE-MTG2734	Max Static	(N)	13	13	6	8	6
		(mm)	4.2	2.8	7.5	7.7	9.5
	Max Dynamic	(N)	38	88	26	20	23
		(mm)	27.0	10.0	17.6	40.0	22.0

Part No.	Force		▼	▲	▼▲	▲	▼▲
	(N)	(mm)					
CABLE-MTG2735	Max Static	(N)	100	100	50	100	50
		(mm)	1.4	1.2	1.7	2.5	1.5
	Max Dynamic	(N)	305	280	343	188	320
		(mm)	6.0	3.4	7.0	8.0	7.0
CABLE-MTG2736	Max Static	(N)	100	100	50	100	50
		(mm)	1.8	1.3	2.0	2.6	2.2
	Max Dynamic	(N)	320	335	345	188	345
		(mm)	8.8	4.1	8.2	11.0	8.7

Part No.	Force		▼	▲	▼▲	▲	▼▲
	(N)	(mm)					
CABLE-MTG2737	Max Static	(N)	50	50	30	35	30
		(mm)	2.4	1.7	4.5	4.3	6.0
	Max Dynamic	(N)	136	240	170	72	118
		(mm)	15.2	7.5	14.5	23.4	15.4
CABLE-MTG2738	Max Static	(N)	45	45	22	35	22
		(mm)	4.0	2.7	6.7	7.3	8.4
	Max Dynamic	(N)	135	342	100	80	100
		(mm)	24.0	10.0	15.8	36.0	20.0

Part No.	Force		▼	▲	▼▲	▲	▼▲
	(N)	(mm)					
CABLE-MTG2739	Max Static	(N)	250	250	125	188	125
		(mm)	1.8	1.5	2.6	2.8	3.5
	Max Dynamic	(N)	750	236	860	460	840
		(mm)	10.0	7.0	8.3	15.0	11.0
CABLE-MTG2740	Max Static	(N)	150	150	100	125	100
		(mm)	2.4	1.3	4.0	3.4	4.1
	Max Dynamic	(N)	400	620	320	255	220
		(mm)	10.4	5.2	10.4	13.8	8.8

Part No.	Force		▼	▲	▼▲	▲	▼▲
	(N)	(mm)					
CABLE-MTG2741	Max Static	(N)	150	150	80	110	80
		(mm)	4.4	1.9	5.7	6.0	5.6
	Max Dynamic	(N)	360	750	330	180	263
		(mm)	17.2	7.0	14.3	18.2	13.5
CABLE-MTG2742	Max Static	(N)	138	138	70	105	70
		(mm)	4.3	3.0	6.4	7.5	8.5
	Max Dynamic	(N)	415	1110	420	250	340
		(mm)	24.0	11.0	24.4	36.0	22.0

Part No.	Force		▼	▲	▼▲	▲	▼▲
	(N)	(mm)					
CABLE-MTG2743	Max Static	(N)	250	250	125	200	125
		(mm)	1.8	1.2	2.2	2.2	2.5
	Max Dynamic	(N)	785	590	700	500	570
		(mm)	8.3	2.6	8.2	11.3	8.1
CABLE-MTG2744	Max Static	(N)	200	200	110	125	110
		(mm)	3.0	2.8	4.1	3.0	5.0
	Max Dynamic	(N)	570	450	680	315	620
		(mm)	13.7	4.8	16.0	17.0	15.0

Part No.	Force		▼	▲	▼▲	▲	▼▲
	(N)	(mm)					
CABLE-MTG2745	Max Static	(N)	150	150	100	100	100
		(mm)	2.2	1.4	4.0	2.3	4.9
	Max Dynamic	(N)	430	1250	825	275	418
		(mm)	11.4	7.5	18.0	18.8	14.5
CABLE-MTG2746	Max Static	(N)	100	100	50	75	50
		(mm)	2.5	1.8	4.5	3.8	4.8
	Max Dynamic	(N)	295	423	400	190	418
		(mm)	15.5	6.3	18.5	25.3	20.2