

## Bushes

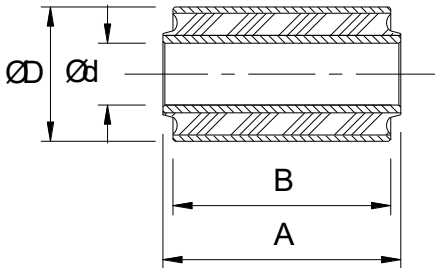

A range of sizes is available from existing tooling. Some parts maybe available from stock although they are normally manufactured to meet customer' requirements.

### Dimensions



GMT Part No	Ød (mm)	ØD (mm)	Length A (mm)	Length B (mm)
BU1259	6.4	17.5	22.2	19.0
BU1260	7.0	18.0	22.2	19.0
BU1269	8.0	25.4	12.0	9.0
BU1262	10.0	22.0	16.0	15.0
BU1264	10.0	24.0	17.0	14.0
BU1265	10.0	24.0	23.5	20.5
BU1263	12.0	22.0	28.0	24.0
BU1268	12.0	25.0	28.0	24.0
BU1270	12.0	28.0	46.0	40.0
BU1272	12.0	30.0	13.0	10.0
BU1273	12.0	30.0	40.0	36.0
BU1816	12.0	30.0	58.0	33.0
BU1274	12.0	30.0	59.0	45.0
BU1277	12.0	32.0	59.0	55.0
BU1989	12.2	60.24	45.5	38.0
BU1278	12.7	38.2	31.8	25.4
BU1282	12.7	41.0	64.0	57.7
BU1267	13.0	25.0	25.0	16.0
BU2027	13.0	30.0	30.0	24.0
BU1611	14.0	40.0	46.0	40.0

## Dimensions

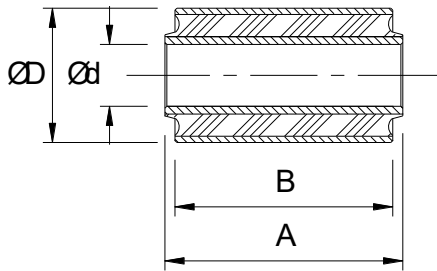

GMT Part No	Ød (mm)	ØD (mm)	Length A (mm)	Length B (mm)
BU1815	16.0	32.0	44.0	35.0
BU1276	16.0	32.0	21.0	19.0
BU1290	16.0	48.0	50.0	45.0
BU2057	16.03	32.05	28.0	25.0
BU1289	17.0	48.0	24.5	16.0
BU1287	20.0	45.0	47.5	40.0
BU1288	20.0	45.0	70.0	64.0
BU1291	20.0	50.0	46.0	40.0
BU1283	21.0	41.25	64.0	51.0
BU1281	22.0	40.0	45.0	40.0
BU1311	22.5	65.0	26.0	16.0
BU1292	24.0	50.0	99.0	86.0
BU1293	24.0	50.0	115.0	102.0
BU1663	24.0	55.0	65.0	55.0
BU1303	24.1	58.5	107.0	100.0
BU1220	28.6	57.1	88.0	85.6
BU1299	30.0	55.0	94.0	89.5
BU1305	30.0	60.0	26.0	24.0
BU1587	30.3	64.0	102.0	97.0
BU1296	32.0	55.0	60.0	58.0
BU1298	32.0	55.0	72.0	64.0

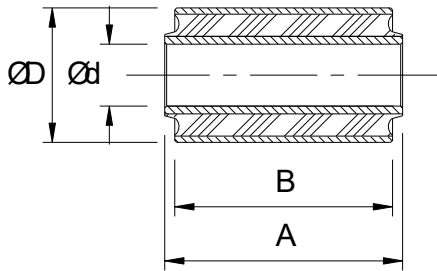
**Dimensions**

GMT Part No	Ød (mm)	ØD (mm)	Length A (mm)	Length B (mm)
BU1300	32.0	57.0	100.0	95.0
BU1307	35.0	60.0	40.0	36.0
BU1228	38.0	63.0	76.0	70.0
BU1159	39.7	63.5	57.3	50.9
BU1160	39.7	63.5	82.7	76.3
BU1197	44.5	76.0	133.5	127.0
BU1165	44.5	76.2	79.4	70.0
BU1104	44.5	76.2	79.6	76.4
BU1198	44.5	78.6	133.4	129.5
BU1327	44.5	127.0	105.0	102.0
BU1315	45.0	75.0	97.5	90.0
BU1316	45.0	75.0	100.0	90.0
BU1318	50.0	78.0	66.0	60.0
BU1635	50.0	85.0	68.0	58.0
BU1324	60.0	118.0	135.0	125.0
BU1326	70.0	125.0	160.0	151.0
BU1325	70.0	125.1	120.0	111.0
BU2042	70.0	126.0	120.0	111.0
BU1331	80.0	140.0	182.0	170.0
BU1330	100.0	140.5	120.0	110.0

## Dimensions

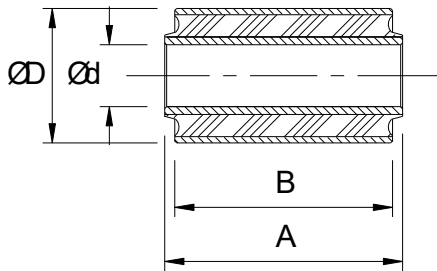

GMT Part No	$\varnothing d$ (mm)	$\varnothing D$ (mm)	Length A (mm)	Length B (mm)
BU1332	100.0	145.0	100.0	89.4
BU1334	100.0	160.0	180.0	172.0
BU1336	112.0	215.0	166.0	152.0

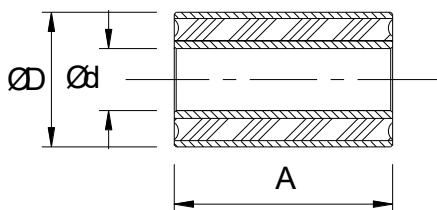

GMT Part No	$\varnothing d$ (mm)	$\varnothing D$ (mm)	Length A (mm)
BU1285	20.0	45.0	30.0
BU1279	22.0	40.0	40.0
BU1142	24.0	48.0	80.0
BU1158	25.4	42.9	25.5
BU1297	30.0	55.0	66.0
BU1308	35.0	60.0	120.0
BU1310	40.0	65.0	15.0
BU1319	48.0	82.0	82.0
BU1328	78.0	128.0	90.0
BU1144	95.0	158.8	12.7
BU1337	150.0	290.0	75.0

## Dimensions

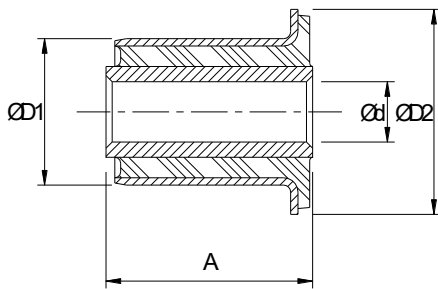

GMT Part No	$\text{Ød}$ (mm)	$\text{ØD1}$ (mm)	$\text{ØD2}$ (mm)	Length A (mm)
BU1163	12.7	29.5	38.0	36.0
BU1223	20.6	50.0	70.0	70.5

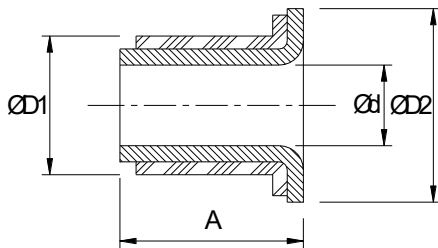

GMT Part No	$\text{Ød}$ (mm)	$\text{ØD1}$ (mm)	$\text{ØD2}$ (mm)	Length A (mm)
BU1209	30.0	43.0	60.0	27.0

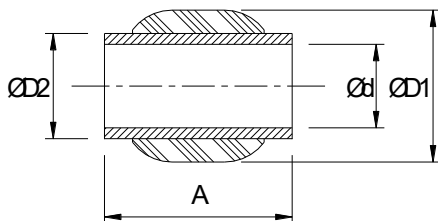

GMT Part No	$\text{Ød}$ (mm)	$\text{ØD1}$ (mm)	$\text{ØD2}$ (mm)	Length A (mm)
BU1373	25.4	46.2	32.0	57.1
BU2031	30.1	60.0	40.1	102

## Dimensions

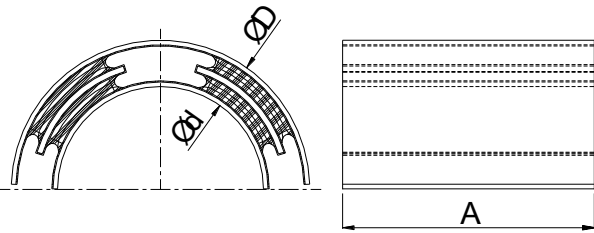

GMT Part No	Ød (mm)	ØD (mm)	Length A (mm)
BU2213	180.0	261.0	220.0

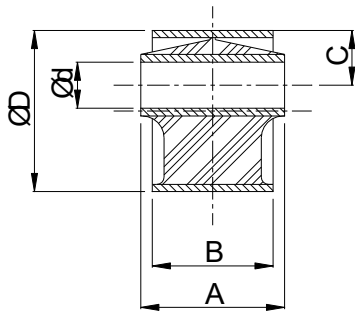

GMT Part No	Ød (mm)	ØD (mm)	Length A (mm)	Length B (mm)	Length C (mm)
BU2229	25.4	88.9	79.4	66.7	(30.15)

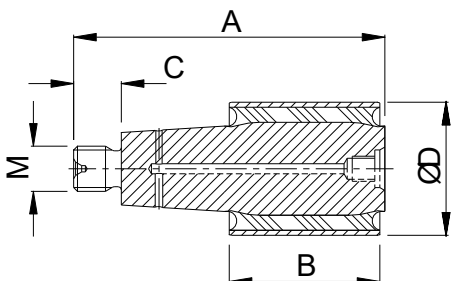

GMT Part No	ØD (mm)	Length B (mm)	Length A (mm)	M	Length C (mm)
BU2217	53.0	60.0	124.0	M18x1.5	19.0